

# Replacement Double-Hung Installation Instructions

## *How to Measure For Pocket Window Installation*

### **When replacing Old Wood Window Sashes:**

*from the inside of the house...*

1. Measure between the side jambs at top, bottom and middle to find the smallest width (**figure 1**).
2. Measure the height from the head jamb to the sill where the inside edge of the bottom sash meets the sill (**figure 2**).
3. Write down the smallest dimensions of the replacement opening in inches to the nearest 1/8" giving width first.
4. The new vinyl window will be made 1/2" less than your measurements, both in width and height to insure sufficient room for proper installation.



(Figure A)

## *How to Measure For Replacement Windows*

### **For Replacement of Old Aluminum or Vinyl Windows:**

In order to determine the correct size for your replacement windows, you'll need to take an accurate measurement of your existing replacement opening.

*from the inside of the house...*

1. If you currently have metal or vinyl windows that have no interior trim, you may need to remove some of the drywall from around the inside perimeter of the recessed window opening.
2. Remove sash and any other storm panels or screens.
3. Measure the width (**figure 1**) and height (**figure 2**) of the opening between the remaining metal frame or tracks. Measure at three spots to find the smallest dimension.
4. Write dimensions in inches to the nearest 1/8" giving width first.
5. The new window will be made 1/2" less than the window opening both in width and height.

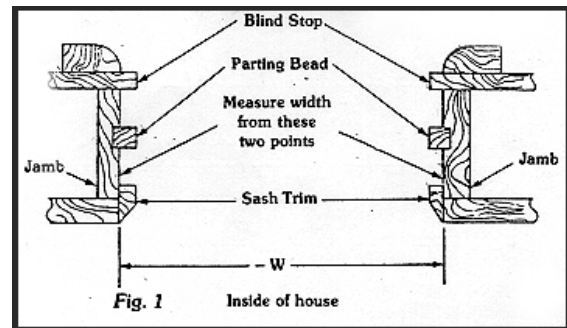

(Figure 1)

### **For Total Replacement of Old Windows:**

In order to determine the correct size for your replacement windows, you'll need to take an accurate measurement of your existing "rough opening".

*from the inside of the house...*

1. Remove the interior trim to expose the rough opening.
2. Measure the width at the top, middle and bottom of the opening to find the smallest measurement. (**figure 1**)
3. Measure the height of the rough opening from the top to the bottom. find the smallest measurement. (**figure 2**)
4. Write dimensions in inches to the nearest 1/8" giving width first.
5. The new window will be made 1/2" less than the window opening both in width and height.

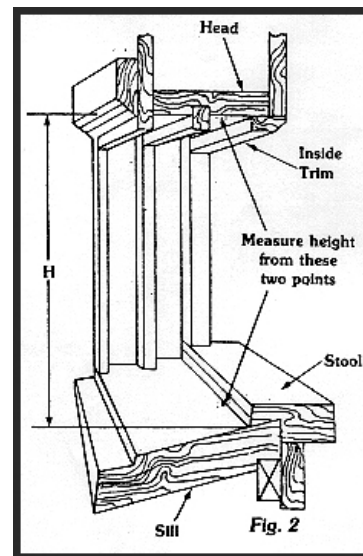

(Figure 2)

# Replacement Double-Hung Installation Instructions

The original window frame will remain in place and only the existing sash must be removed. Read these instructions thoroughly before beginning.

REMEMBER TO USE APPROPRIATE PERSONAL PROTECTIVE EQUIPMENT

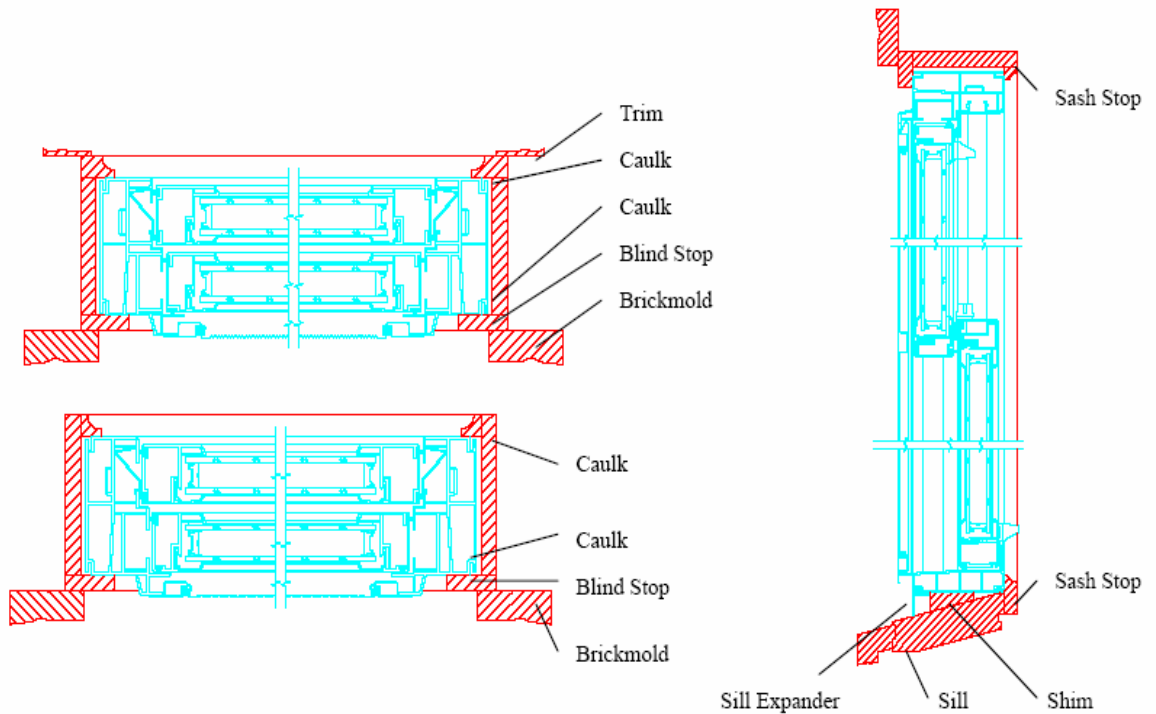

## 1

### DOUBLE-HUNG SASH REMOVAL

**CAUTION:**

*Many windows in older homes are painted with lead-based paint. Removal of old windows may disturb this paint.*

*Proper precautions must be taken to minimize exposure to dust and debris.*

Note: Verify the unit opening prior to removing the existing sash.

- A. **Score paint or varnish** along interior sash stops with a sharp utility knife. Remove the interior sash stops at jambs (sides) and head (top) using a putty knife and pry bar.
- B. **Remove the parting stops** by prying them out or by pulling them with a channel lock.
- C. **Remove sash** and aluminum or vinyl liners.

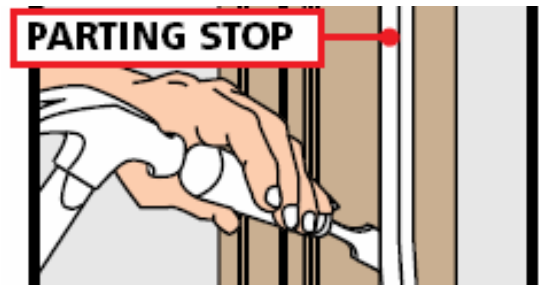

# 2 PREPARING THE OPENING

- A **Remove cardboard and clear tape from all four corners of unit**, which was applied to the unit during shipping
- B **Test fit the window.** The window should be approximately 1/2" smaller than the opening in the height and width. Verify that the installation screws will be fastened into solid material.
- C **Place a bead of sealant** where the sill and jamb meet.
- D. **Apply sill flashing tape.** Cut a piece 12" longer than the opening width. Apply tape to the bottom of opening as shown in (2D). Do not allow the tape to go past the blind stops. Tape should extend up both sides of opening by 6".
- E. **Check to ensure the sill is level.** Place cedar shims about 1/2" from each side and center. Once the unit is level attach shims to prevent movement. Improper placement may cause bowing in new frame.

2C

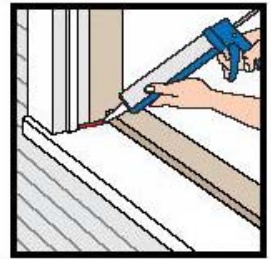

2D

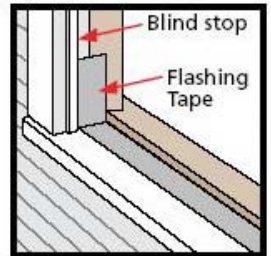

2E

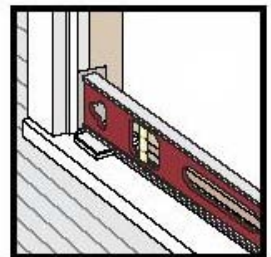

# 3 Sealing and Fastening the Window

- A. **Apply a continuous bead of sealant** to the interior face of the existing blind stops at the head and both jambs.
- B. **Place a bead of sealant** where the existing stool meets the existing frame sill and jambs.
- C. **Insert window into the opening.** Set the bottom of the window in first and tilt top into place. Make sure the window is centered in opening and press firmly against blind stops. Cut and install sill expander to determined height and width.
- D. **Place a shim at each of the top corners even** with the pre-drilled holes, and insert screws. This will hold the unit while you square and shim the unit.
- E **Place screws and shims into both sides of frame** where the prep for replacement holes are drilled. Raise bottom sash to install the lower installation screws.
- G **Check for correct installation** and squareness by making sure the diagonal measurement from corner to corner is within 1/16" in both directions. (3E) Check for plumb at top/center/ bottom of unit. Use your eye to verify that the sill is level. If you see a crown, shim the unit more until the crown is removed. Finally check to make sure that the sightlines are correct by sighting the sash and main frame interfaces, checking for consistent gaps. The gaps should be equal between the sash and frame on the head, sill and jambs.

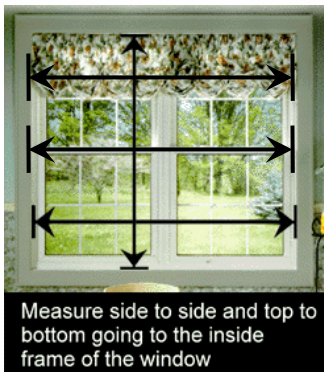
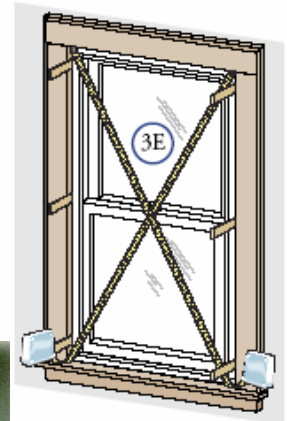
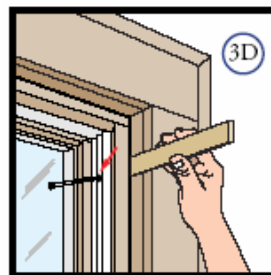
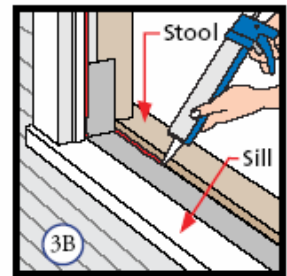
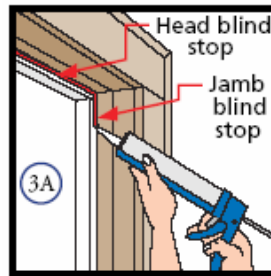

# 4 Interior Seal

- A. **Apply a low expansion insulation foam.** From the interior, insert the nozzle of the applicator approximately 1” deep into the space between the window and the rough opening and apply a 1” deep band of foam. This will allow room for expansion of the foam and will minimize squeeze out. Allow the foam to cure completely.
- B. **Check window operation** by opening and closing the window.  
*Note: If there are any problems with the operation of the window, recheck the shim locations and adjust for plumb and square.*

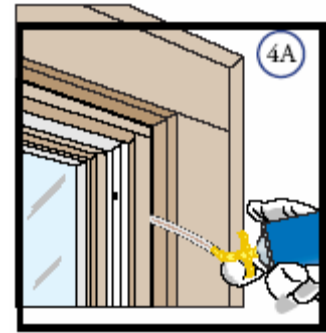

# 5 Exterior Seal

- A **Apply a bead of caulk** to the entire perimeter of the window.
- B **Check to ensure the sill expander is properly seated and sealed.** If the window sill appears to be humped in the center, carefully push sill down to straighten.

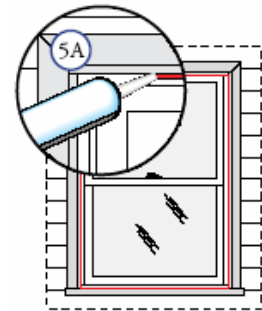

# Types of Installations

There are a variety of ways to replace old windows in your home. Following is a brief outline of the various options.

## 1. Pocket Replacement System:

- "Pocket" refers to inserting, (or pocketing), an energy efficient, maintenance-free window into your existing window frame.
- Designed specifically to renovate wooden double hung windows.
- The Current frame and sill must be in good condition and structurally sound. The opening must be reasonably square and plumb.
- The main advantage of pocket installation, is that you can install a new window, without disturbing existing interior trim.
- The old sash and balances are removed and disposed of properly. Interior stops are removed and retained for reuse.
- The new window is slid into the pocket and secured with screws.

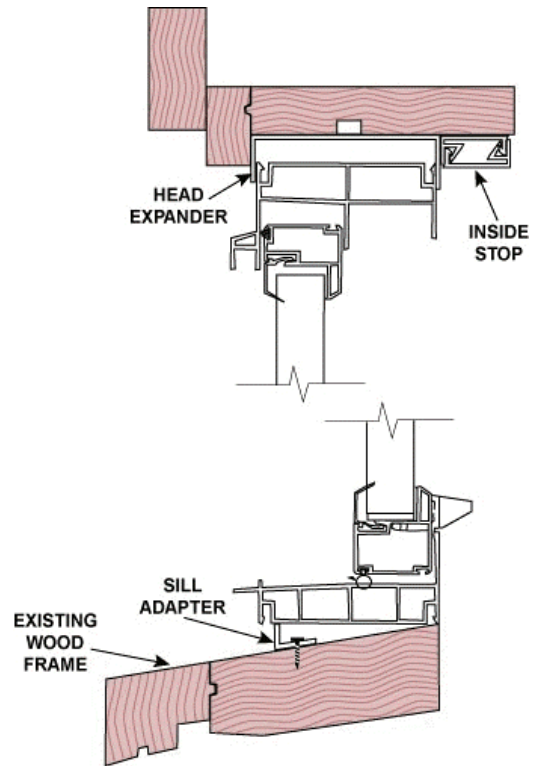

## 2. Replacing an Aluminum Window:

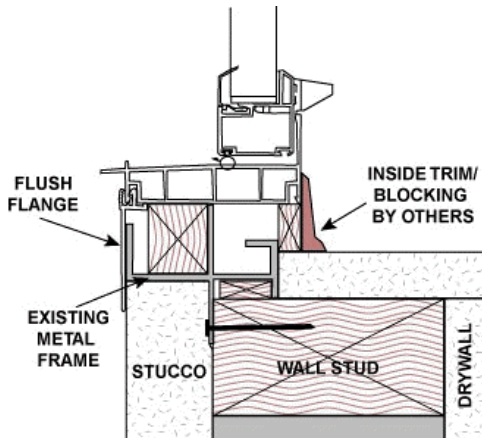

- In many instances it is desirable to replace aluminum windows without removing the entire frame.
- Refer to drawing for suggested method

## 3. Total Replacement System

- Replaces your entire window or patio door. You will need to completely remove the old window, including the sill, frame and trim
- The advantage of the total replacement system is that you will have new windows that will add beauty and energy-efficiency to your home. If your current windows are unsightly or deteriorated, total replacement can made a dramatic difference.
- With total replacement, you'll have more choices as well. Choose from casements, awnings, double hungs, single hungs, horizontal sliders, picture, or bow and bay windows.
- You can replace your old windows with larger windows. By replacing small windows with larger ones, you'll bring in more sunshine and ventilation, giving you a warmer, cozier feeling. Two, three or more windows can be installed side-by-side for a custom window wall.
- The major requirement for a total replacement is that you provide a structurally sound opening for the new replacement window.